



1977'den
Berî Dünyanın Yükünü
Taşıyoruz..

2022 ÜRÜN KATALOĞU



DALGIC®
SANAYİ & MOBİLYA TEKERLERİ

1977

www.dalgicteker.com.tr

1977 yılında Ünver Dalgıç tarafından kurulan Dalgıç Teker firması, ürettiği sanayi ve mobilya tekerlerinin ve mümessili olduğu teker firmaları ile gücüne güç katarak ilerlemektedir. Prensiplerimiz; müşteri memnuniyeti, garanti, anında temin ve Türkiye'nin yanısıra tüm dünya ülkelerine sevkiyat yapmaktadır.

Biz, siz müşterilerimizin de beğenisini kazanmış bir firma olarak, inandık ki mutluluğumuzu arttırmanın yolu müşterilerimizin memnuniyetini ve bize olan güvenini arttırmaktan geçmektedir.

DALGIÇ TEKER A.Ş. - Sanayi Tekerleri Satışı





051											
50	20	71					M8		124	40	
Delikli boş teker / Bolthole caster											



059											
50	20	75	49x49	34x34	7				159	35	
Döner tablalı ahşap teker / Swivel plate wood caster											



052											
50	20	71					M8		142	40	
Delikli boş frenli teker / Bolthole caster with brake											



060											
50	20	75	49x49	34x34	7				177	35	
Döner tablalı frenli ahşap teker / Swivel plate wood caster with brake											



053											
50	20	79					3/8	16	130	40	
Döner civatalı teker / Swivel bolted caster											



061											
50	20	75	49x49	34x34	7				160	35	
Döner tablalı şeffaf teker / Swivel UUZ plate transparent caster											



054											
50	20	79					3/8	16	143	40	
Döner civatalı teker / Swivel bolted caster											



062											
50	20	75	74x19	61	4				164	40	
Döner UUZ tablalı teker / Swivel UUZ plate caster											



055											
50	20	79					3/8	16	162	40	
Döner civatalı frenli teker / Swivel bolted caster with brake											



063											
50	20	75	74x19	61	4				173	40	
Döner UUZ tablalı teker / Swivel UUZ plate caster											



056											
50	20	75	49x49	34x34	7				155	40	
Döner tablalı teker / Swivel plate caster											



064											
50	20	75	74x19	61	4				191	40	
Döner UUZ tablalı frenli teker / Swivel UUZ plate caster with brake											



057											
50	20	75	49x49	34x34	7				164	40	
Döner tablalı teker / Swivel plate caster											



065											
50	20	75	49x49	34x34	7				104	40	
Sabit maşalı teker / Fixed caster											



058											
50	20	75	49x49	34x34	7				182	40	
Döner tablalı frenli teker / Swivel plate caster with brake											



066											
50	20	75	49x49	34x34	7				114	40	
Sabit maşalı teker / Fixed caster											



067

50	20	61			8.3	27	105 40

Pimli proller için teker / For socket plastic caster



075

75	25	100			3/8	16	292 50

Döner civatalı frenli teker / Swivel bolted caster with brake



068

28	14	37	45x30	36x20	5		44 20

Döner tablalı teker / Swivel plate caster



076

75	25	98	65x65	47x47	8		270 50

Döner tablalı teker / Swivel plate caster



069

28	14	37			7	40	37 20

Uzun özel pimli teker / Special long stem caster



077

75	25	98	65x65	47x47	8		320 50

Döner tablalı teker / Swivel plate caster



070

75	25	96			M8		214 50

Delikli boş teker / Bolthole caster



078

75	25	98	65x65	47x47	8		345 50

Döner tablalı frenli teker / Swivel plate caster with brake



071

75	25	96			M8		254 50

Delikli boş teker / Bolthole caster



079

75	25	98	65x65	47x47	8		315 50

Döner tablalı ahşap teker / Swivel plate wood caster



072

75	25	96			M8		271 50

Delikli boş frenli teker / Bolthole caster with brake



080

75	25	92	85x38	60	9		255 45

Sabit maşalı teker / Fixed caster



073

75	25	100			3/8	16	236 50

Döner civatalı teker / Swivel bolted caster



081

75	25	92	85x38	60	9		259 45

Sabit maşalı teker / Fixed caster



074

75	25	100			3/8	16	275 50

Döner civatalı teker / Swivel bolted caster

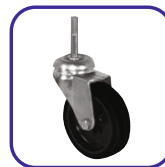

082

75	25	100			M8	50	242 40

Uzun özel civatalı teker / Special long bolted caster

083

50	19x2	65				3/8	15	82	35

Döner civatalı çiftli teker / Swivel bolted twin caster

091

50	19x2	68	35x19		4			108	35

Döner U tabanlı çiftli frenli teker / Swivel U plate twin caster with brake

084

50	19x2	68	45x45	32x32	4			107	35

Döner tabanlı çiftli teker / Swivel plate twin caster

092

50	19x2	68	74x19	61	4			124	35

Döner UUZ tabanlı çiftli frenli teker / Swivel UUZ plate twin caster with brake

085

50	19x2	68	35x19		4			104	35

Döner U tabanlı çiftli teker / Swivel U plate twin caster

093

50	19x2	57				8.3	36	85	35

Pimli proller için çiftli frenli teker / For socket plastic twin caster with brake

086

50	19x2	68	74x19	61	4			120	35

Döner UUZ tabanlı çiftli teker / Swivel UUZ plate twin caster

094

50	19x2	64				11	21	90	35

Pimli çelik halkalı çiftli frenli teker / Stem with ring twin caster with brake

087

50	19x2	57				8.3	36	81	35

Pimli proller için çiftli teker / For socket plastic twin caster

095

50	16x2	70				3/8	15	93	30

Döner civatalı çiftli renkli teker / Swivel bolted double color caster

088

50	19x2	64				11	21	85	35

Pimli çelik halkalı çiftli teker / Stem with ring twin caster

096

50	16x2	71	45x45	32x32	4			113	30

Döner tabanlı çiftli renkli teker / Swivel plate double color caster

089

50	19x2	65				3/8	15	86	35

Döner civatalı çiftli frenli teker / Swivel bolted twin caster with brake

097

50	16x2	71	35x19		4			108	30

Döner U tabanlı çiftli renkli teker / Swivel U plate double color caster

090

50	19x2	68	45x45	32x32	4			110	35

Döner tabanlı çiftli frenli teker / Swivel plate twin caster with brake

098

50	16x2	71	74x19	61	4			124	30

Döner UUZ tabanlı çiftli renkli teker / Swi. UUZ plate double color castr



035											
50	20	61				8.3	27	79	35		
Pimli profiller için teker / For socket plastic caster											



043											
38	15	50					6	26	39	15	
Pimli proller için teker / For socket plastic caster											



036											
50	20	61				8.3	27	89	35		
Pimli profiller için teker / For socket plastic caster											



044											
50	20	70					3/8	16	99	30	
Döner civatalı teker / Swivel bolted caster											



037											
50	20	71				M8		212	50		
Delikli boş çiftli teker / Bolthole twin caster											



045											
50	20	70					3/8	16	110	30	
Döner civatalı teker / Swivel bolted caster											



038											
50	20	71				M8		221	50		
Delikli boş çiftli teker / Bolthole twin caster											



046											
50	20	66	43x39	29x26	4			103	30		
Döner civatalı teker / Swivel bolted caster											



039											
50	20	76				3/8	16	232	50		
Döner civatalı çiftli teker / Swivel bolted twin caster											



047											
50	20	66	43x39	29x26	4			114	30		
Döner tablalı teker / Swivel plate caster											



040											
50	20	76				3/8	16	241	50		
Döner civatalı çiftli teker / Swivel bolted twin caster											



048											
50	20	66	64x33	48	6.5			102	30		
Döner dar tablalı teker / Swivel plate caster											



041											
50	20	73	65x65	48x48	8			296	50		
Döner tablalı çiftli teker / Swivel plate twin caster											



049											
50	20	66	64x33	48	6.5			113	30		
Döner dar tablalı teker / Swivel plate caster											



042											
50	20	73	65x65	48x48	8			305	50		
Döner tablalı çiftli teker / Swivel plate twin caster											



050											
50	20	71				M8		111	40		
Delikli boş teker / Bolthole caster											

SM-028

28	14	43	21x20					28	18

Sabit maşalı teker / Fixed caster

DMV-050

50	20	72					3/8	16	99 35

Döner civatalı teker / Swivel bolted caster

SM-032

32	15	42	36x21					36	20

Sabit maşalı teker / Fixed caster

DKMV-050

50	20	72					3/8	16	111 35

Döner civatalı teker / Swivel bolted caster

SM-032

32	15	45	38x21					38	22

Sabit maşalı teker / Fixed caster

DM-050

50	20	71	43x39	29x26	4			116	35

Döner tablalı teker / Swivel plate caster

SM-028

28	14	34	46x21	36	5			27	15

Sabit maşalı teker / Fixed caster

DKM-050-1

50	20	71	43x39	29x26	4			127	35

Döner tablalı teker / Swivel plate caster

SM-032

32	15	42	53x21	39	5			41	20

Sabit maşalı teker / Fixed caster

DKM-050-LU

50	20	72	35x19		4			127	35

Sabit maşalı teker / Fixed caster

SM-038

38	15	48	57x21	45	5			46	25

Sabit maşalı teker / Fixed caster

SM-050

50	20	69	67x29	51	7			92	35

Sabit maşalı teker / Fixed caster

SM-050

50	20	53	49x27					65	30

Sabit maşalı teker / Fixed caster

SKM-050

50	20	69	67x29	51	7			102	35

Sabit maşalı teker / Fixed caster

SKM-050

50	20	53	49x27					75	30

Sabit maşalı teker / Fixed caster

SKM-050-2

50	20	69	67x29	51	7			112	35

Sabit maşalı teker / Fixed caster

35 mm AĞIR YÜK TAŞIYICI TEKERLEKLER



KOD	DP-035 V								
Çift Sıra Bilyalı Tekerlek, Rulmanlı									
TEKERLEK ÇAPI	YERDEN YÜKSEKLİK	TAŞIMA KAPASİTESİ	BAĞLANTI TİPİ	BAĞLANTI ÖLÇÜSÜ	GÖVDE MALZEMESİ	TEKERLEK MALZEMESİ	ÜRÜN AĞIRLIĞI	PAKET ADEDİ	BİRİM FİYATI
35	56	90	Cıvatalı	M10	Metal	PA+TPU	173	8	₺



KOD	DP-035 VF								
Çift Sıra Bilyalı Tekerlek, Frenli, Rulmanlı									
TEKERLEK ÇAPI	YERDEN YÜKSEKLİK	TAŞIMA KAPASİTESİ	BAĞLANTI TİPİ	BAĞLANTI ÖLÇÜSÜ	GÖVDE MALZEMESİ	TEKERLEK MALZEMESİ	ÜRÜN AĞIRLIĞI	PAKET ADEDİ	BİRİM FİYATI
35	56	90	Cıvatalı	M10	Metal	PA+TPU	193	8	₺



KOD	DP-035								
Çift Sıra Bilyalı Tekerlek, Rulmanlı									
TEKERLEK ÇAPI	YERDEN YÜKSEKLİK	TAŞIMA KAPASİTESİ	BAĞLANTI TİPİ	BAĞLANTI ÖLÇÜSÜ	GÖVDE MALZEMESİ	TEKERLEK MALZEMESİ	ÜRÜN AĞIRLIĞI	PAKET ADEDİ	BİRİM FİYATI
35	54	90	Tablalı	50 x 50	Metal	PA+TPU	209	8	₺



KOD	DP-035 F								
Çift Sıra Bilyalı Tekerlek Frenli, Rulmanlı									
TEKERLEK ÇAPI	YERDEN YÜKSEKLİK	TAŞIMA KAPASİTESİ	BAĞLANTI TİPİ	BAĞLANTI ÖLÇÜSÜ	GÖVDE MALZEMESİ	TEKERLEK MALZEMESİ	ÜRÜN AĞIRLIĞI	PAKET ADEDİ	BİRİM FİYATI
35	54	90	Tablalı	50 x 50	Metal	PA+TPU	265	8	₺



KOD	DP-035 VM								
Çift Sıra Bilyalı Tekerlek, Siyah									
TEKERLEK ÇAPI	YERDEN YÜKSEKLİK	TAŞIMA KAPASİTESİ	BAĞLANTI TİPİ	BAĞLANTI ÖLÇÜSÜ	GÖVDE MALZEMESİ	TEKERLEK MALZEMESİ	ÜRÜN AĞIRLIĞI	PAKET ADEDİ	BİRİM FİYATI
35	56	90	Cıvatalı	M10	Metal	PA	152	8	₺



KOD	DP-035 VMF								
Çift Sıra Bilyalı Tekerlek, Frenli, Siyah									
TEKERLEK ÇAPI	YERDEN YÜKSEKLİK	TAŞIMA KAPASİTESİ	BAĞLANTI TİPİ	BAĞLANTI ÖLÇÜSÜ	GÖVDE MALZEMESİ	TEKERLEK MALZEMESİ	ÜRÜN AĞIRLIĞI	PAKET ADEDİ	BİRİM FİYATI
35	56	90	Cıvatalı	M10	Metal	PA	172	8	₺



KOD	DM-035								
Çift Sıra Bilyalı Tekerlek, Rulmanlı									
TEKERLEK ÇAPI	YERDEN YÜKSEKLİK	TAŞIMA KAPASİTESİ	BAĞLANTI TİPİ	BAĞLANTI ÖLÇÜSÜ	GÖVDE MALZEMESİ	TEKERLEK MALZEMESİ	ÜRÜN AĞIRLIĞI	PAKET ADEDİ	BİRİM FİYATI
35	54	90	Tablalı	50 x 50	Metal	PA	186	8	₺



KOD	DM-035 F								
Çift Sıra Bilyalı Tekerlek, Frenli, Rulmanlı									
TEKERLEK ÇAPI	YERDEN YÜKSEKLİK	TAŞIMA KAPASİTESİ	BAĞLANTI TİPİ	BAĞLANTI ÖLÇÜSÜ	GÖVDE MALZEMESİ	TEKERLEK MALZEMESİ	ÜRÜN AĞIRLIĞI	PAKET ADEDİ	BİRİM FİYATI
35	54	90	Tablalı	50 x 50	Metal	PA	203	8	₺



KOD	DD-035 V								
Çift Sıra Bilyalı Tekerlek, Alüminyum, Rulmanlı									
TEKERLEK ÇAPI	YERDEN YÜKSEKLİK	TAŞIMA KAPASİTESİ	BAĞLANTI TİPİ	BAĞLANTI ÖLÇÜSÜ	GÖVDE MALZEMESİ	TEKERLEK MALZEMESİ	ÜRÜN AĞIRLIĞI	PAKET ADEDİ	BİRİM FİYATI
35	56	90	Cıvatalı	M10	Metal	AL	234	8	₺



KOD	DD-035								
Çift Sıra Bilyalı Tekerlek, Alüminyum, Rulmanlı									
TEKERLEK ÇAPI	YERDEN YÜKSEKLİK	TAŞIMA KAPASİTESİ	BAĞLANTI TİPİ	BAĞLANTI ÖLÇÜSÜ	GÖVDE MALZEMESİ	TEKERLEK MALZEMESİ	ÜRÜN AĞIRLIĞI	PAKET ADEDİ	BİRİM FİYATI
35	54	90	Tablalı	50 x 50	Metal	AL	244	8	₺



KOD	SD-035								
Sabit Maşalı Alüminyum, Rulmanlı									
TEKERLEK ÇAPI	YERDEN YÜKSEKLİK	TAŞIMA KAPASİTESİ	BAĞLANTI TİPİ	BAĞLANTI ÖLÇÜSÜ	GÖVDE MALZEMESİ	TEKERLEK MALZEMESİ	ÜRÜN AĞIRLIĞI	PAKET ADEDİ	BİRİM FİYATI
35	40	90	Sabit	32 x 56	Metal	AL	113	8	₺



KOD	SP-035								
Sabit Maşalı Tekerlek, Rulmanlı									
TEKERLEK ÇAPI	YERDEN YÜKSEKLİK	TAŞIMA KAPASİTESİ	BAĞLANTI TİPİ	BAĞLANTI ÖLÇÜSÜ	GÖVDE MALZEMESİ	TEKERLEK MALZEMESİ	ÜRÜN AĞIRLIĞI	PAKET ADEDİ	BİRİM FİYATI
35	56	90	Sabit	38 x 63	Metal	PA+TPU	127	8	₺



POLYAMİD ÜSTÜ POLİÜRETAN

Çift Dizi Oynak	Yataklama							kg
DPP-080-R		80	30	75x102	45x74-50x82	9	107	30
DPP-100-R		100	35	110x110	72x72-82x82	11	135	75
DPP-100-R		100	35	110x110	72x72-82x82	11	135	75
DPP-125-R		125	40	110x110	72x72-82x82	11	160	200
DPP-125-R		125	40	110x110	72x72-82x82	11	160	200
DPP-150-R		150	45	110x110	72x72-82x82	11	185	200
DPP-200-R		170	45	110x110	72x72-82x82	11	202	200



POLYAMİD ÜSTÜ POLİÜRETAN

Sabit	Yataklama							kg
SPP-080		80	30	75x102	45x74-50x82	9	107	150
SPP-100		100	35	110x110	72x72-82x82	11	135	175
SPP-100-R		100	35	110x110	72x72-82x82	11	135	175
SPP-125		125	40	110x110	72x72-82x82	11	160	200
SPP-125-R		125	40	110x110	72x72-82x82	11	160	200
SPP-150		150	45	110x110	72x72-82x82	11	185	220
SPP-200		170	45	110x110	72x72-82x82	11	202	220



POLYAMİD ÜSTÜ POLİÜRETAN

Tablalı Frenli	Yataklama							kg
DPP-080-RF		80	30	75x102	45x74-50x82	9	107	150
DPP-100-RF		100	35	110x110	72x72-82x82	11	135	175
DPP-100-RF		100	35	110x110	72x72-82x82	11	135	175
DPP-125-RF		125	40	110x110	72x72-82x82	11	160	200
DPP-125-RF		125	40	110x110	72x72-82x82	11	160	200
DPP-150-RF		150	45	110x110	72x72-82x82	11	185	220
DPP-200-RF		170	45	110x110	72x72-82x82	11	202	220



POLYAMİD TEKERLER (ORTA YÜK)













Çift Dizi Oynak	Yataklama							kg	Tablalı Frenli
DP-080		80	30	75x102	45x74-50x82	9	107	150	-
DP-100		100	35	110x110	72x72-82x82	11	135	175	DP-100F
DP-100-R		100	35	110x110	72x72-82x82	11	135	175	DP-100-RF
DP-125		125	40	110x110	72x72-82x82	11	160	200	DP-125F
DP-125-R		125	40	110x110	72x72-82x82	11	160	200	DP-125-RF
DP-150		150	45	110x110	72x72-82x82	11	185	220	DP-150F
DP-170		170	45	110x110	72x72-82x82	11	202	220	DP-170F
DP-200-R		200	45	110x110	72x72-82x82	11	250	220	DP-200F













Sabit	Yataklama							kg
SP-080		80	30	75x102	45x74-50x82	9	107	150
SP-100		100	35	110x110	72x72-82x82	11	135	175
SP-125		125	40	110x110	72x72-82x82	11	160	200
SP-150		150	45	110x110	72x72-82x82	11	185	220
SP-170		170	45	110x110	72x72-82x82	11	202	280
SP-200		200	45	110x110	72x72-82x82	11	250	350

POLYAMİD TEKERLER (PASLANMAZ)















Tablalı Oynak	Yataklama								Tablalı Frenli
DP-080		80	30	85x100	60x80	9	106	120	DP-080F
DP-100		100	30	85x100	60x80	9	127	140	DP-100F
DP-125		125	38	85x100	60x80	9	157	160	DP-125F
DP-150		150	40	85x100	60x80	9	181	180	DP-150F
DP-200		200	50	110x110	82x52	9	250	300	DP-200F















Sabit	Yataklama							
SP-080		80	30	85x100	60x80	9	106	120
SP-100		100	30	85x100	60x80	9	127	140
SP-125		125	38	85x100	60x80	9	157	160
SP-150		150	40	85x100	60x80	9	181	180

POLYAMİD ÜSTÜ POLİÜRETAN TEKERLER (PASLANMAZ)













Tablalı Oynak	Yataklama								Tablalı Frenli
DPP-080		80	30	85x100	60x80	9	106	120	DPP-080F
DPP-100		100	30	85x100	60x80	9	127	140	DPP-100F
DPP-125		125	40	85x100	60x80	9	157	160	DPP-125F
DPP-150		150	45	85x100	60x80	9	165		DPP-150F
DPP-200		200	50	85x100	60x80	9	250		DPP-200F



Sabit	Yataklama							
SPP-080		80	30	85x100	60x80	9	106	120
SPP-100		100	30	85x100	60x80	9	127	140
SPP-125		125	40	85x100	60x80	9	157	160
SPP-150		150	45	85x100	60x80	9	157	160
SPP-200		200	50	85x100	60x80	9	157	160

GRI LASTİK













Tablalı Oynak	Yataklama								Tablalı Frenli
DT-210-100		100	20	68x78	50x60	8	135	50	DT-212-100F
DT-210-125		125	25	68x78	50x60	8	163	60	DT-212-125F
DT-210-150		150	25	68x78	50x60	8	190	70	DT-212-150F



PVC KAPLI (SEDYE GRUBU)













Oynak	Yataklama								Frenli
DT-505-100		100	32	68x78	50x60	8	135	60	DT-507-100F
DT-505-100		100	32	68x78	50x60	8	135	60	DT-507-100F
DT-505-125		125	32	68x78	50x60	8	163	80	DT-507-125F
DT-505-125		125	32	68x78	50x60	8	163	80	DT-507-125F



PVC KAPLI (SEDYE GRUBU)













Oynak	Yataklama							Frenli
DT-308-100		100	32	25x25 / 30x30 / 40x40	16	135	60	DT-310-100F
DT-308-100		100	32	25x25 / 30x30 / 40x40	16	135	60	DT-310-100F
DT-308-125		125	32	25x25 / 30x30 / 40x40	16	163	80	DT-310-125F
DT-308-125		125	32	25x25 / 30x30 / 40x40	16	163	80	DT-310-125F



PVC KAPLI (SEDYE GRUBU)











Oynak	Yataklama							Frenli
DT-308-100		100	32	5/8"	16	135	60	DT-310-100F
DT-308-100		100	32	5/8"	16	135	60	DT-310-100F
DT-308-125		125	32	5/8"	16	163	80	DT-310-125F
DT-308-125		125	32	5/8"	16	163	80	DT-310-125F



PVC KAPLI (SEDYE GRUBU)















Oynak	Yataklama							Frenli
DT-303-100		100	32	3/8"	16	132	60	DT-306-100F
DT-303-100		100	32	3/8"	16	132	60	DT-306-100F
DT-303-125		125	32	3/8"	16	163	80	DT-306-125F
DT-303-125		125	32	3/8"	16	163	80	DT-306-125F



LASTİK TEKERLER















Tablalı Oynak	Yataklama								kg	Tablalı Frenli
DT-101-080		80	25	75x102	75x102	9	106	60	DT-102-080F	
DT-101-100		100	30	110x110	72x72x82x82	9	135	100	DT-102-100F	
DT-101-125		125	38	110x110	72x72x82x82	9	160	125	DT-102-125F	
DT-101-150		150	40	110x110	72x72x82x82	9	185	150	DT-102-150F	
DT-101-175		200	50	140x110	72x72x82x82	11	204	230	DT-101-175F	
DT-101-200		200	50	140x110	72x72x82x82	11	240	250	DT-101-200F	



LASTİK TEKERLER







Sabit	Yataklama								kg
DT-103-080		80	25	75x102	75x102	9	106	60	
DT-103-100		100	30	110x110	72x72x82x82	9	135	100	
DT-103-125		125	38	110x110	72x72x82x82	9	160	125	
DT-103-150		150	40	110x110	72x72x82x82	9	185	150	
DT-103-175		175	50	140x110	72x72x82x82	11	204	230	
DT-103-200		200	50	140x110	72x72x82x82	11	240	250	



KOD	105-B	Antik Servis Arabası Tekerleği								
TEKERLEK ÇAPI	YERDEN YÜKSEKLİK	TAŞIMA KAPASİTESİ	BAĞLANTI TİPİ	BAĞLANTI ÖLÇÜSÜ	GÖVDE MALZEMESİ	TEKERLEK MALZEMESİ	ÜRÜN AĞIRLIĞI	PAKET ADEDİ	BİRİM FİYATI	
										
105	121	30	Tablalı	50 x 50	Metal	TPU	260	12	₺	













KOD	105-K	Krom Servis Arabası Tekerleği								
TEKERLEK ÇAPI	YERDEN YÜKSEKLİK	TAŞIMA KAPASİTESİ	BAĞLANTI TİPİ	BAĞLANTI ÖLÇÜSÜ	GÖVDE MALZEMESİ	TEKERLEK MALZEMESİ	ÜRÜN AĞIRLIĞI	PAKET ADEDİ	BİRİM FİYATI	
										
105	121	30	Tablalı	50 x 50	Metal	TPU	260	12	₺	













KOD	105-S	Sarı Servis Arabası Tekerleği								
TEKERLEK ÇAPI	YERDEN YÜKSEKLİK	TAŞIMA KAPASİTESİ	BAĞLANTI TİPİ	BAĞLANTI ÖLÇÜSÜ	GÖVDE MALZEMESİ	TEKERLEK MALZEMESİ	ÜRÜN AĞIRLIĞI	PAKET ADEDİ	BİRİM FİYATI	
										
105	121	30	Tablalı	50 x 50	Metal	TPU	260	12	₺	













KOD NO											KOLI ADEDİ
											BOX QUANTITY
DP-505-080	80	25			12		104	0,415	50	50	
DP-505-100	100	30			12		128	0,505	70	30	
DP-505-125	125	37,5			12		155	0,710	100	25	
DP-505-150	150	40			12		181	0,880	120	16	













KOD NO											KOLI ADEDİ
											BOX QUANTITY
DPF-505-080	80	25			12		104	0,540	50	40	
DPF-505-100	100	30			12		128	0,595	70	30	
DPF-505-125	125	37,5			12		155	0,855	100	20	
DPF-505-150	150	40			12		181	1,075	120	16	













KOD NO											KOLI ADEDİ
											BOX QUANTITY
DPP-506-080	80	25			12		104	0,577	50	50	
DPP-506-100	100	30			12		128	0,758	70	30	
DPP-506-125	125	37,5			12		155	1,134	100	25	
DPP-506-150	150	40			12		181	1,435	120	16	













KOD NO											KOLI ADEDİ
											BOX QUANTITY
DPPF-506-080	80	25			12		104	0,702	50	40	
DPPF-506-100	100	30			12		128	0,848	70	30	
DPPF-506-125	125	37,5			12		155	1,279	100	20	
DPPF-506-150	150	40			12		181	1,600	120	16	















KOD NO											KOLI ADEDİ
											BOX QUANTITY
DL-507-080	80	25			12		104	0,577	50	50	
DL-507-100	100	30			12		128	0,758	70	30	
DL-507-125	125	37,5			12		155	1,134	100	25	
DL-507-150	150	40			12		181	1,435	120	16	



KOD NO											KOLI ADEDİ
											BOX QUANTITY
DLF-507-080	80	25			12		104	0,702	50	40	
DLF-507-100	100	30			12		128	0,848	70	30	
DLF-507-125	125	37,5			12		155	1,279	100	20	
DLF-507-150	150	40			12		181	1,600	120	16	

POLYAMİD TEKERLER





















Tablalı Oynak	Yataklama								kg	Tablalı Frenli
DP-055		55	25	70x92	45x66	8	80	100	-	
DP-080		80	30	85x100	60x80	9	106	120	DP-080F	
DP-100		100	30	85x100	60x80	9	127	140	DP-100F	
DP-125		125	38	85x100	60x80	9	157	160	DP-125F	
DP-150		150	40	85x100	60x80	9	181	180	DP-150F	
DP-200		200	50	110x110	82x52	9	250	300	DP-200F	





















POLYAMİD TEKERLER



Sabit	Yataklama								kg
DPP-055		55	25	70x92	45x66	8	80	100	
DPP-080		80	30	85x100	60x80	9	118	150	
DPP-080-5R		80	30	85x100	60x80	9	118	150	
DPP-100		100	35	115x140	80x105	11	137	175	
DPP-100-5R		100	35	115x140	80x105	11	137	175	
DPP-125		125	40	115x140	80x105	11	172	250	
DPP-125-5R		125	40	115x140	80x105	11	172	250	
DPP-150x45		150	45	115x140	80x105	11	209	350	
DPP-150x45-5R		150	45	115x140	80x105	11	209	350	
DPP-200		200	50	115x140	80x105	11	250	450	
DPP-200-5R		200	50	115x140	80x105	11	250	450	

POLYAMİD ÜSTÜ POLİÜRETAN





















Tablalı Oynak	Yataklama								kg	Tablalı Frenli
DPP-055		55	25	70x92	45x66	8	80	100	-	
DPP-080		80	30	85x100	60x80	9	118	150	DPP-080F	
DPP-080-5R		80	30	85x100	60x80	9	118	150	DPP-080F-5R	
DPP-100		100	35	115x140	80x105	11	137	175	DPP-100F	
DPP-100-5R		100	35	115x140	80x105	11	137	175	DPP-100F-5R	
DPP-125		125	40	115x140	80x105	11	172	250	DPP-125F	
DPP-125-5R		125	40	115x140	80x105	11	172	250	DPP-125F-5R	
DPP-150x45		150	45	115x140	80x105	11	209	350	DPP-150x45F	
DPP-150x45-5R		150	45	115x140	80x105	11	209	350	DPP-150x45F-5R	
DPP-200		200	50	115x140	80x105	11	250	450	DPP-200F	
DPP-200-5R		200	50	115x140	80x105	11	250	450	DPP-200F-5R	















POLYAMİD ÜSTÜ POLİÜRETAN















Sabit	Yataklama								kg
SPP-055		55	25	70x92	45x66	8	80	100	
SPP-080		80	30	85x100	60x80	9	118	150	
SPP-080-5R		80	30	85x100	60x80	9	118	150	
SPP-100		100	35	115x140	80x105	11	137	175	
SPP-100-5R		100	35	115x140	80x105	11	137	175	
SPP-125		125	40	115x140	80x105	11	172	250	
SPP-125-5R		125	40	115x140	80x105	11	172	250	
SPP-150x45		150	45	115x140	80x105	11	209	350	
SPP-150x45-5R		150	45	115x140	80x105	11	209	350	
SPP-200		200	50	115x140	80x105	11	250	450	
SPP-200-5R		200	50	115x140	80x105	11	250	450	

DÖKÜM ÜSTÜ POLİÜRETAN















Tablalı Oynak	Yataklama								Tablalı Frenli
DPD-080		80	30	85x100	60x80	9	118	200	DPD-080F
DPD-100		100	35	115x140	80x105	11	137	400	DPD-100F
DPD-125		125	40	115x140	80x105	11	172	600	DPD-125F
DPD-150x45		150	45	115x140	80x105	11	209	750	DPD-150x45F
DPD-200		200	50	115x140	80x105	11	250	800	DPD-200F















Sabit	Yataklama							
SPD-080		80	30	85x100	60x80	9	118	200
SPD-100		100	35	115x140	80x105	11	137	400
SPD-125		125	40	115x140	80x105	11	172	600
SPD-150x45		150	45	115x140	80x105	11	209	750
SPD-200		200	50	115x140	80x105	11	250	800

DÖKÜM ÜSTÜ POLİÜRETAN (BALIK SIRTİ)





















Tablalı Oynak	Yataklama								Tablalı Frenli
DPD-080-DVR		80	30	85x100	60x80	9	118	200	DPD-080F-DVR
DPD-100-DVR		100	35	115x140	80x105	11	137	400	DPD-100F-DVR
DPD-125-DVR		125	40	115x140	80x105	11	172	600	DPD-125F-DVR
DPD-150x45-DVR		150	45	115x140	80x105	11	209	750	DPD-150x45F-DVR
DPD-200-DVR		200	50	115x140	80x105	11	250	800	DPD-200F-DVR





















Sabit	Yataklama							
SPD-080-DVR		80	30	85x100	60x80	9	118	200
SPD-100-DVR		100	35	115x140	80x105	11	137	400
SPD-125-DVR		125	40	115x140	80x105	11	172	600
SPD-150x45-DVR		150	45	115x140	80x105	11	209	750
SPD-200-DVR		200	50	115x140	80x105	11	250	800

DÖKÜM TEKERLER





































Oynak	Yataklama								kg	Frenli
DD-055		55	25	70x92	45x66	8	80	125	-	
DD-080		80	30	85x100	60x80	9	118	250	DD-080F	
DD-080-5R		80	30	85x100	60x80	9	118	250	DD-080F-5R	
DD-100		100	35	115x140	80x105	11	137	400	DD-100F	
DD-100-5R		100	35	115x140	80x105	11	137	400	DD-100F-5R	
DD125		125	40	115x140	80x105	11	172	500	DD-125F	
DD-125-5R		125	40	115x140	80x105	11	172	500	DD-125F-5R	
DD-150		150	50	115x140	80x105	11	209	750	DD-150F	
DD-150-5R		150	50	115x140	80x105	11	209	750	DD-150F-5R	
DD-200		200	50	115x140	80x105	11	250	800	DD-200F	
DD-200-5R		200	50	115x140	80x105	11	250	800	DD-200F-5R	



Sabit	Yataklama								kg
SD-055		55	25	70x92	45x66	8	80	125	
SD-080		80	30	85x100	60x80	9	118	250	
SD-080-5R		80	30	85x100	60x80	9	118	250	
SD-100		100	35	115x140	80x105	11	137	400	
SD-100-5R		100	35	115x140	80x105	11	137	400	
SD-125		125	40	115x140	80x105	11	172	500	
SD-125-5R		125	40	115x140	80x105	11	172	500	
SD-150		150	50	115x140	80x105	11	209	750	
SD-150-5R		150	50	115x140	80x105	11	209	750	
SD-200		200	50	115x140	80x105	11	250	800	
SD-200-5R		200	50	115x140	80x105	11	250	800	











DÖKÜM ÜSTÜ LASTİK TEKERLER

Oynak	Yataklama								kg	Frenli
DDL-055		55	25	70x92	45x66	8	80	125	-	
DDL-080		80	30	85x100	60x80	9	118	250	DDL-080F	
DDL-080-5R		80	30	85x100	60x80	9	118	250	DDL-080F-5R	
DDL-100		100	35	115x140	80x105	11	137	400	DDL-100F	
DDL-100-5R		100	35	115x140	80x105	11	137	400	DDL-100F-5R	
DDL-125		125	40	115x140	80x105	11	172	500	DDL-125F	
DDL-125-5R		125	40	115x140	80x105	11	172	500	DDL-125F-5R	
DDL-150		150	50	115x140	80x105	11	209	750	DDL-150F	
DDL-150-5R		150	50	115x140	80x105	11	209	750	DDL-150F-5R	
DDL-200		200	50	115x140	80x105	11	250	800	DDL-200F	
DDL-200-5R		200	50	115x140	80x105	11	250	800	DDL-200F-5R	
Sabit	Yataklama								kg	
DSL-055		55	25	70x92	45x66	8	80	125		
DSL-080		80	30	85x100	60x80	9	118	250		
DSL-080-5R		80	30	85x100	60x80	9	118	250		
DSL-100		100	35	115x140	80x105	11	137	400		
DSL-100-5R		100	35	115x140	80x105	11	137	400		
DSL-125		125	40	115x140	80x105	11	172	500		
DSL-125-5R		125	40	115x140	80x105	11	172	500		
DSL-150		150	50	115x140	80x105	11	209	750		
DSL-150-5R		150	50	115x140	80x105	11	209	750		
DSL-200		200	50	115x140	80x105	11	250	800		
DSL-200-5R		200	50	115x140	80x105	11	250	800		











POLYAMİD TEKERLER











Oynak	Yataklama								kg	Frenli
DP-150-10R		150	45	115x140	80x105	11	220	500		DP-150F-10R
DP-200-10R		200	50	115x140	80x105	11	265	800		DP-200F-10R











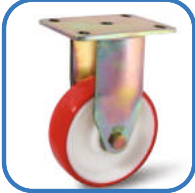

Sabit	Yataklama								kg
SP-150-10R		150	45	115x140	80x105	11	220	500	
SP-200-10R		200	50	115x140	80x105	11	265	800	

POLYAMİD ÜSTÜ POLİÜRETAN











Oynak	Yataklama								kg	Frenli
DPP-150-10R		150	45	115x140	80x105	11	220	350		DPP-150F-10R
DPP-200-10R		200	50	115x140	80x105	11	265	450		DPP-200F-10R











Sabit	Yataklama								kg
SPP-150-10R		150	45	115x140	80x105	11	220	350	
SPP-200-10R		200	50	115x140	80x105	11	265	450	

DÖKÜM ÜSTÜ POLİÜRETAN











Oynak	Yataklama								kg	Frenli
DPD-150-10R		150	45	115x140	80x105	11	220	800		DPD-150F-10R
DPD-200-10R		200	50	115x140	80x105	11	265	1000		DPD-200F-10R











Sabit	Yataklama								kg
SPD-150-10R		150	45	115x140	80x105	11	220	800	
SPD-200-10R		200	50	115x140	80x105	11	265	1000	

BUTE RULMANLI DÖKÜM ÜSTÜ POLİÜRETAN (BALIK SIRTİ)



Oynak	Yataklama								kg	Frenli
DPD-150-10RB		150	45	115x140	80x105	11	220	800		DPD-150F-10RB
DPD-200-10RB		200	50	115x140	80x105	11	265	1000		DPD-200F-10RB











Sabit	Yataklama								kg
SPD-150-10RB		150	45	115x140	80x105	11	220	800	
SPD-200-10RB		200	50	115x140	80x105	11	265	000	

Tekerlek 55 Döküm Göbekli Poliüretan

Sertlik	□ □ □ □ □	92 Shore A
Ortam Sıcaklığı	□ □ □ □ □	-25 °C - +70 °C
Yuvarlanma Direnci	□ □ □ □ □	Mükemmel
Yürüyüş Gürültüsü	□ □ □ □ □	İyi
Zemin Koruması	□ □ □ □ □	İyi



Oynak	Yatak Türü								Frenli
DPD-222-150x45		150	45	140x175	105x140	15	220	800	DPD223-F-150x45F
DPD-222-200x50		200	50	140x175	105x140	15	265	1000	DPD223-F-200x50F
DPD-222-200x60		200	60	140x175	105x140	15	265	1200	DPD223-F-200x60F
DPD-222-250x60		250	60	140x175	105x140	15	320	1300	DPD223-F-250x60F
DPD-222-250x80		250	80	140x175	105x140	15	320	1400	DPD223-F-250x80F
DPD-222-300x70		300	70	140x175	105x140	15	364	1500	DPD223-F-300x70F
DPD-222-350x80		350	80	140x175	105x140	15	412	1800	DPD223-F-350x80F



Sabit	Yatak Türü							
SPD224-150x45		150	45	140x175	105x140	15	220	800
SPD224-200x50		200	50	140x175	105x140	15	265	1000
SPD224-200x60		200	60	140x175	105x140	15	265	1200
SPD224-250x60		250	60	140x175	105x140	15	320	1300
SPD224-250x80		250	80	140x175	105x140	15	320	1400
SPD224-300x70		300	70	140x175	105x140	15	364	1500
SPD224-350x80		350	80	140x175	105x140	15	412	1800

10 mm kalınlığında Çelik tabla ve maşa kaynaklı dizayn. Su ve toz ile teması engelleyen üst çanak. Çelik malzemeden CNC de hassas işlenmiş rulman yatağı. Yüksek manevra kabiliyeti sağlayan büte ve konik rulman. Konik rulmanda su ve toz önleyici kapak. Rulmanların yağlanması için gresörlük.



Tekerlek 20 Döküm Göbekli Ağır Tip Lastik

Sertlik	□ □ □ □ □	80 - 85 Shore A
Ortam Sıcaklığı	□ □ □ □ □	-25 °C - +80 °C
Yuvarlanma Direnci	□ □ □ □ □	İyi
Yürüyüş Gürültüsü	□ □ □ □ □	Mükemmel
Zemin Koruması	□ □ □ □ □	Mükemmel

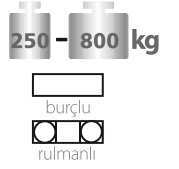

Oynak	Yatak Türü							kg	Frenli
DDL-222-170	□ □ □ □ □	170	50	140x175	105x140	15	240	250	DDL223-F-170F
DDL-222-200	□ □ □ □ □	200	50	140x175	105x140	15	265	300	DDL223-F-200F
DDL-222-220	□ □ □ □ □	220	60	140x175	105x140	15	285	400	DDL223-F-220F
DDL-222-250	□ □ □ □ □	250	70	140x175	105x140	15	320	500	DDL223-F-250F
DDL-222-300	□ □ □ □ □	300	75	140x175	105x140	15	364	700	DDL223-F-300F
DDL-222-360	□ □ □ □ □	360	85	140x175	105x140	15	417	800	DDL223-F-360F



Sabit	Yatak Türü							kg
SDL224-170	□ □ □ □ □	150	45	140x175	105x140	15	240	250
SDL224-200	□ □ □ □ □	200	50	140x175	105x140	15	265	300
SDL224-220	□ □ □ □ □	200	60	140x175	105x140	15	285	400
SDL224-250	□ □ □ □ □	250	60	140x175	105x140	15	320	500
SDL224-300	□ □ □ □ □	250	80	140x175	105x140	15	364	700
SDL224-360	□ □ □ □ □	300	70	140x175	105x140	15	417	800

Çatı: H176



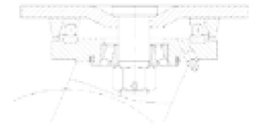







10 mm kalınlığında Çelik tabla ve maşa kaynaklı dizayn. Su ve toz ile teması engelleyen üst çanak. Çelik malzemeden CNC de hassas işlenmiş rulman yatağı. Yüksek manevra kabiliyeti sağlayan büte ve konik rulman. Konik rulmanda su ve toz önleyici kapak. Rulmanların yağlanması için gresörlük.













Tekerlek 50 Döküm

Sertlik	□ □ □ □ □	180 HB	□ □ □ □ □
Ortam Sıcaklığı	□ □ □ □ □	-40 °C - +550 °C	□ □ □ □ □
Yuvarlanma Direnci	□ □ □ □ □	Mükemmel	□ □ □ □ □
Yürüyüş Gürültüsü	□ □ □ □ □	Zayıf	□ □ □ □ □
Zemin Koruması	□ □ □ □ □	Zayıf	□ □ □ □ □



Oynak	Yatak Türü							
DD100-101-150		150	50	140x175	105x140	15	220	750
DD100-101-200		200	50	140x175	105x140	15	265	1000
DD100-101-250		250	60	140x175	105x140	15	320	1200



Sabit	Yatak Türü							
SD100-102-150		150	45	140x175	105x140	15	220	800
SD100-102-200		200	50	140x175	105x140	15	265	1000
SD100-102-250		250	60	140x175	105x140	15	320	1200





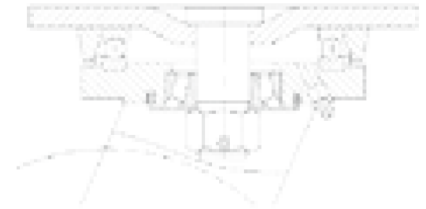







Çatı: H176













10 mm kalınlığında Çelik tabla ve maşa. Kaynaklı dizayn. Su ve toz ile teması engelleyen üst çanak. Çelik malzemedeki hassas işlenmiş rulman yatağı. Yüksek manevra kabiliyeti sağlayan büte ve konik rulman. Konik rulmanda su ve toz önleyici kapak. Rulmanların yağlanması için gresörlük.































DÖKÜM ÜSTÜ POLİÜRETAN ÇİFTLİ













Oynak	Yataklama							kg
606-200X50		200	50	200x250	160x210	17	280	2000
606-200X60		200	60	200x250	160x210	17	280	2400
606-250X60		250	60	200x250	160x210	17	335	2600
606-250X80		250	80	200x250	160x210	17	335	2800
606-300X70		300	70	200x250	160x210	17	380	3000
606-350x80		350	80	200x250	160x210	17	426	3500
606-400X120		400	120	300x400	240x340	26	530	5000

Sabit	Yataklama							kg
608-200X50		200	50	200x250	160x210	17	280	2000
608-200X60		200	60	200x250	160x210	17	280	2400
608-250X60		250	60	200x250	160x210	17	335	2600
608-250X80		250	80	200x250	160x210	17	335	2800
608-300X70		300	70	200x250	160x210	17	380	3000
608-350x80		350	80	200x250	160x210	17	426	3500
608-400X120		400	120	300x400	240x340	26	530	5000









DÖKÜM ÜSTÜ POLİÜRETAN ÇİFTLİ (BALIK SIRTİ)

Oynak	Yataklama							kg
606-200X50-B		200	50	200x250	160x210	17	280	2000
606-200X60-B		200	60	200x250	160x210	17	280	2400
606-250X60-B		250	60	200x250	160x210	17	335	2600
606-250X80-B		250	80	200x250	160x210	17	335	2800
606-300X70-B		300	70	200x250	160x210	17	380	3000
606-350x80-B		350	80	200x250	160x210	17	426	3500
606-400X120-B		400	120	300x400	240x340	26	530	5000









Sabit	Yataklama							kg
608-200X50-B		200	50	200x250	160x210	17	280	2000
608-200X60-B		200	60	200x250	160x210	17	280	2400
608-250X60-B		250	60	200x250	160x210	17	335	2600
608-250X80-B		250	80	200x250	160x210	17	335	2800
608-300X70-B		300	70	200x250	160x210	17	380	3000
608-350x80-B		350	80	200x250	160x210	17	426	3500
608-400X120-B		400	120	300x400	240x340	26	530	5000

Döner Frenli	Yataklama							kg
609-200X50-B		200	50	200x250	160x210	17	280	2000
609-200X60-B		200	60	200x250	160x210	17	280	2400
609-250X60-B		250	60	200x250	160x210	17	335	2600
609-250X80-B		250	80	200x250	160x210	17	335	2800
609-300X70-B		300	70	200x250	160x210	17	380	3000
609-350x80-B		350	80	200x250	160x210	17	426	3500
609-400X120-B		400	120	300x400	240x340	26	530	5000











Oynak	Yataklama							kg
DPD-606-200X50		200	50	140x175	105x140	15	275/250	1000
DPD-606-250x60		250	60	140x175	105x140	15	330/300	1250











Sabit	Yataklama							kg
DPD-608-200X50		200	50	140x175	105x140	15	275/250	1000
DPD-608-250x60		250	60	140x175	105x140	15	330/300	1250

HAVALI TEKERLER (PLASTİK)











Döner	Yataklama							kg
H-202-200X50		200	50	140x110	75x105	15	240	200
H-202-260x85		260	85	190x170	135x125	15	310	200











Sabit	Yataklama							kg
H-204-200X50		200	50	140x110	75x105	15	240	200
H-204-260x85		260	85	190x170	135x125	15	310	200

HAVALI TEKERLER (METAL)











Sabit	Yataklama							kg
H-101-200X50		200	50	140x110	75x105	15	240	200
H-101-260x85		260	85	190x170	135x125	15	310	200











Sabit	Yataklama							kg
H-103-200X50		200	50	140x110	75x105	15	240	200
H-103-260x85		260	85	190x170	135x125	15	310	200

SÜSPANSİYONLU (POLYAMİD)











Oynak	Yataklama							kg	Frenli
SS-303-150		150	45	115x140	80x105	11	220/203	500	SS-306-150F
SS-303-200		200	50	115x140	80x105	11	275/255	800	SS-306-200F











Sabit	Yataklama							kg
SS-308-150		150	45	115x140	80x105	11	220/203	500
SS-308-200		200	50	115x140	80x105	11	275/255	800

SÜSPANSİYONLU POLYAMİD ÜSTÜ POLİÜRETAN











Oynak	Yataklama							kg	Frenli
PP-303-150		150	45	115x140	80x105	11	220/203	350	PP-306-150F
PP-303-200		200	50	115x140	80x105	11	275/255	450	PP-306-200F











Oynak	Yataklama							kg
PP-308-150		150	45	115x140	80x105	11	220/203	350
PP-308-200		200	50	115x140	80x105	11	275/255	450

DÖKÜM ÜSTÜ POLİÜRETAN (SÜSPANSİYONLU)

























Oynak	Yataklama							kg	Frenli
DPD-303-150		150	45	115x140	80x105	11	220/203	800	DPD-306-150F
DPD-303-200		200	50	115x140	80x105	11	275/255	1000	DPD-306-200F

































Sabit	Yataklama							kg
DPD-308-150		150	45	115x140	80x105	11	220/203	800
DPD-308-200		200	50	115x140	80x105	11	275/255	1000



SAC JANTLI LASTİK TEKERLER (BURÇLU)

Tekerlekler	Yataklama					
120-080x25x12		80	25	35	12	60
120-100x30x12		100	30	35	12	75
120-100x35x15		100	35	47	15	100
120-125x38x15		125	38	45	15	110
120-125x40x15		125	40	47	15	125
120-150x40x15		150	40	45	15	130
120-150x45x15		150	45	47	15	150
120-175x45x15		175	45	47	15	160
120-200x40x17		200	40	59	17	180
120-200x40x20		200	40	59	20	180
120-200x50x17		200	50	66	17	180
120-200x50x20		200	50	66	20	180
120-220x45x17		220	45	59	17	200
120-220x45x20		220	45	59	20	200
120-250x50x20		250	50	59	20	200
120-250x50x25		250	50	68	25	200
120-300x60x20		300	60	78	20	250
120-300x60x25		300	60	78	25	250





































SAC JANTLI LASTİK TEKERLER (RULMANLI)

Tekerlekler	Yataklama					
121-150x45x15		150	45	47	15	150
121-175x45x15		175	45	47	15	160
121-200x40x17		200	40	54	17	180
121-200x40x20		200	40	55	20	180
121-200x50x17		200	50	59	17	180
121-200x50x20		200	50	64	20	180
121-220x45x17		220	45	54	17	200
121-220x45x20		220	45	55	20	200
121-250x50x20		250	50	68	20	200
121-250x50x25		250	50	68	25	200
121-250x80x20		250	80	93	20	250
121-250x80x25		250	80	93	25	250
121-300x60x20		300	60	78	20	250
121-300x60x25		300	60	82	25	250
121-300x60x30		300	60	82	30	250
121-300x80x20		300	80	78	20	300
121-300x80x25		300	80	82	25	300
121-300x80x30		300	80	82	30	300
121-350x65x25		350	65	88	25	300
121-350x65x30		350	65	88	30	300
121-350x80x25		350	80	88	25	350
121-350x80x30		350	80	88	30	350
121-400x70x25		400	70	92	25	350
121-400x70x30		400	70	92	30	350
121-400x100x25		400	100	92	25	400
121-400x100x30		400	100	92	30	400





SAC JANT HAVALI LASTİK TEKERLER

Tekerlekler	Yataklama	Kat	Kalınlığı				kg
60120-35-415		4	1,5	381	90	20	225
60125-35-415		4	1,5	381	90	25	225
60130-35-415		4	1,5	381	90	30	225
60120-35-420		4	2	381	90	20	250
60125-35-420		4	2	381	90	25	250
60130-35-420		4	2	381	90	30	250
60120-40-415		4	1,5	408	105	20	250
60125-40-415		4	1,5	408	105	25	250
60130-40-415		4	1,5	408	105	30	250
60120-40-420		4	2	408	105	20	275
60125-40-420		4	2	408	105	25	275
60130-40-420		4	2	408	105	30	275
60120-40-427		4	2,75	408	105	20	300
60125-40-427		4	2,75	408	105	25	300
60130-40-427		4	2,75	408	105	30	300
60120-40-615		6	1,5	408	105	20	275
60125-40-615		6	1,5	408	105	25	275
60130-40-615		6	1,5	408	105	30	275
60120-40-620		6	2	408	105	20	300
60125-40-620		6	2	408	105	25	300
60130-40-620		6	2	408	105	30	300
60120-40-627		6	2,75	408	105	20	325
60125-40-627		6	2,75	408	105	25	325
60130-40-627		6	2,75	408	105	30	325
60120-40-115		10	1,5	408	105	20	300
60125-40-115		10	1,5	408	105	25	300
60130-40-115		10	1,5	408	105	30	300
60120-40-120		10	2	408	105	20	325
60125-40-120		10	2	408	105	25	325
60130-40-120		10	2	408	105	30	325
60120-40-127		10	2,75	408	105	20	350
60125-40-127		10	2,75	408	105	25	350
60130-40-127		10	2,75	408	105	30	350











Dış Lastik	Ölçü	Kat
60-35-4	3.50-8	4
60-40-4	4.00-8	4
60-40-6	4.00-8	6
60-40-10	4.00-8	10

İç Lastik	Ölçü
60-35	3.50-8
60-40	4.00-8





















DÖKÜM ÜSTÜ LASTİK TEKER

Tekerlekler	Yataklama					kg
181-080x30x15		80	30	30	15	100
181-100x40x15		100	40	40	15	150
181-125x40x15		125	40	40	15	200
181-150x50x17		150	50	55	17	250













POLYAMİD BURÇLU TEKERLER

Tekerlekler	Yataklama					kg
001P-050x20x09		50	20	21	9	50
002P-055x25x12		55	25	28	12	100
003P-070x23x09		70	23	25	9	100
004P-080x30x12		80	30	33	12	170
005P-x30x15		80	30	34	15	200
006P-100x30x12		100	30	35	12	250
007P-100x35x15		100	35	44	15	280
008P-125x38x15		125	38	44	15	375
009P-125x40x15		125	40	44	15	400
010P-150x40x15		150	40	44	15	425
011P-150x45x15		150	45	48	15	450
012P-150x45x17		150	45	50	17	450
013P-150x50x17		150	50	57	17	500
014P-170x45x15		170	45	56	15	600
015P-200x50x20		200	50	59	20	800













POLYAMİD RULMANLI TEKERLER

001-PR-080x30x15		80	30	34	15	200
002-PR-100x35x15		100	35	44	15	280
003-PR-125x40x15		125	40	45	15	400
004-PR-150x45x17		150	45	50	17	450
005-PR-150x50x17		150	50	56	17	500
006-PR-170x50x20		170	50	55	20	700
007-PR-180x50x20		180	50	56	20	750
008-PR-200x50x17		200	50	59	17	800
009-PR-200x50x20		200	50	59	20	800
010-PR-200x50x25		200	50	59	25	800











POLYAMİD ÜSTÜ POLİÜRETAN TEKERLER (BURÇLU)

Tekerlekler	Yataklama					kg
PPB-080x30x15		80	30	34	15	150
PPB-100x30x12		100	30	35	12	140
PPB-100x35x15		100	35	45	15	175
PPB-125x40x15		125	40	45	15	250
PPB-150x45x17		150	45	50	17	350
PPB-200x50x20		200	50	60	20	450





























POLYAMİD ÜSTÜ POLİÜRETAN TEKERLER (RULMANLI)



























Tekerlekler	Yataklama					kg
PPR-080x30x15		80	30	34	15	150
PPR-100x35x15		100	35	45	15	175
PPR-125x40x15		125	40	45	15	250
PPR-150x45x17		150	45	50	17	350
PPR-200x50x20		200	50	60	20	450



DÖKÜM ÜSTÜ POLİÜRETAN TEKERLER





Tekerlekler	Yataklama					kg
PD-080x30x15		80	30	30	15	200
PD-100x35x15		100	35	40	15	400
PD-125x40x15		125	40	45	15	600
PD-150x45x17		150	45	50	17	750
PD-170x50x20		170	50	55	20	800
PD-200x42x20		200	42	51	20	750
PD-200x50x20		200	50	55	20	1000
PD-200x50x25		200	50	55	25	1000
PD-200x60x25		200	60	60	25	1200
PD-200x80x25		200	80	80	25	1300
PD-250x60x30		250	60	70	30	1300
PD-250x80x30		250	80	80	30	1400
PD-300x70x25		300	70	78	25	1500
PD-300x70x30		300	70	78	30	1500
PD-300x100x35		300	100	108	35	1700
PD-350x80x30		350	80	90	30	1800
PD-360x75x35		360	75	75	35	2000
PD-380x60x50		380	60	65	50	2700
PD-380x75x30		380	75	75	30	2800
PD-400x75x30		400	75	75	30	3000
PD-400x100x30		400	100	100	30	3200
PD-400x120x60		400	120	120	60	3500

DÖKÜM ÜSTÜ POLİÜRETAN TEKERLER (BALIK SIRTİ)

Tekerlekler	Yataklama					
PD-080x30x15-B		80	30	30	15	200
PD-100x35x15-B		100	35	40	15	400
PD-125x40x15-B		125	40	45	15	600
PD-150x45x17-B		150	45	50	17	750
PD-170x50x20-B		170	50	55	20	800
PD-200x42x20-B		200	42	51	20	750
PD-200x50x20-B		200	50	55	20	1000
PD-200x50x25-B		200	50	55	25	1000
PD-200x60x25-B		200	60	60	25	1200
PD-200x80x25-B		200	80	80	25	1300
PD-250x60x30-B		250	60	70	30	1300
PD-250x80x30-B		250	80	80	30	1400
PD-300x70x25-B		300	70	78	25	1500
PD-300x70x30-B		300	70	78	30	1500
PD-300x100x35-B		300	100	108	35	1700
PD-350x80x30-B		350	80	90	30	1800
PD-360x75x35-B		360	75	75	35	2000
PD-380x60x50-B		380	60	65	50	2700
PD-380x75x30-B		380	75	75	30	2800
PD-400x75x30-B		400	75	75	30	3000
PD-400x100x30-B		400	100	100	30	3200
PD-400x120x60-B		400	120	120	60	3500



MERDİVEN TEKERLERİ

Oynak	Yataklama	
T500-120-150		150
T500-121-150		150
T500-300-150		250











Moblen, termoplastik kaplı rulmanlı tekerlek / PP covered by thermoplastic wheel ball bearing (Light duty)

KOD NO								KOLİ ADEĐİ BOX QUANTITY
MER 10035	100	35	15	50	0,280	120	50	
MER 12540	125	40	15	50	0,386	130	40	
MER 15045	150	45	15	50	0,553	160	32	
MER 20050	200	50	20	60	1,095	200	20	

















DÖKÜM TEKERLER (BURÇLU)











Tekerlekler	Yataklama					kg
YDB-055x25x12		55	25	28	12	125
YDB-080x30x15		80	30	35	15	250
YDB-100x35x15		100	35	48	15	400
YDB-125x40x15		125	40	46	15	500
YDB-150x50x17		150	50	58	17	750
YDB-200x50x20		200	50	57	20	1000
YDB-200x50x25		200	50	57	25	1000



DÖKÜM TEKERLER (RULMANLI)









Tekerlekler	Yataklama					kg
YDR-080x30x15		80	30	35	15	250
YDR-100x35x15		100	35	40	15	400
YDR-125x40x15		125	40	40	15	500
YDR-150x50x17		150	50	55	17	750
YDR-200x50x20		200	50	58	20	1000
YDR-200x50x25		200	50	55	25	1000
YDR-200x50x30		200	50	55	30	1000
YDR-250x60x30		250	60	65	30	1250

POLYAMİD TRANSPALET TEKERLERİ

Tekerlekler	Yataklama					kg
TP-070x60x17		70	60	62	17	350
TP-070x60x20		70	60	62	20	350
TP-085x60x17		85	60	62	17	400
TP-085x60x20		85	60	62	20	400
TP-085x70x17		85	70	72	17	400
TP-085x70x20		85	70	72	20	400









DÖKÜM ÜSTÜ POLİÜRETAN TRANSPALET TEKERLERİ

Tekerlekler	Yataklama					kg
TPD-085x60x17		85	60	62	17	500
TPD-085x60x20		85	60	62	20	500
TPD-085x70x17		85	70	72	17	500
TPD-085x70x20		85	70	72	20	500







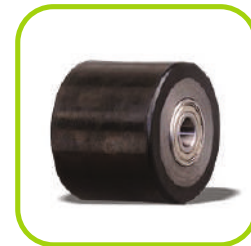























DÖKÜM ÜSTÜ LASTİK TRANSPALET TEKERLERİ

















Tekerlekler	Yataklama					kg
TLD-085x70x17		85	70	72	17	250
TLD-085x70x20		85	70	72	20	250



DÖKÜM LASTİK TEKERLER







Tekerlekler	Yataklama					
LD-160x50x25		160	50	50	25	200
LD-170x50x17		170	50	56	17	250
LD-170x50x20		170	50	56	20	250
LD-200x50x17		200	50	55	17	300
LD-200x50x20		200	50	55	20	300
LD-200x50x25		200	50	55	25	300
LD-200x60x25		200	60	60	25	325
LD-200x80x25		200	80	80	25	350
LD-220x60x25		220	60	60	25	400
LD-250x70x25		250	70	70	25	500
LD-250x70x30		250	70	70	30	500
LD-250x80x30		300	80	80	30	600
LD-300x75x25		300	75	75	25	700
LD-300x75x30		300	75	75	30	700
LD-300x75x35		300	75	75	35	700
LD-360x85x30		360	85	85	30	800
LD-360x85x35		360	85	85	35	800
LD-360x85x40		360	85	85	40	800
LD-400x75x25		400	75	75	25	900
LD-400x75x30		400	75	75	30	900
LD-400x100x30		400	100	100	30	1000
LD-400x100x35		400	100	100	35	1000
LD-510x150x45		510	150	150	45	1600
LD-560x100x45		560	100	125	45	1250

DÖKÜM LASTİK TEKERLER

Tekerlekler	Yataklama					
LDD-170x50x17		170	50	56	17	200
LDD-170x50x20		170	50	56	20	200
LDD-200x60x25		200	60	67	25	250
LDD-220x60x25		220	60	68	25	325
LDD-300x70x25		300	70	77	25	400
LDD-300x70x30		300	70	77	30	400
LDD-300x70x35		300	70	77	35	400
LDD-380x85x30		380	85	94	30	630
LDD-380x85x35		380	85	94	35	630
LDD-200x35x20		200	35	50	20	175
LDD-350x70x25		300	70	73	25	300
LDD-350x70x30		350	70	73	30	300









MOBLEN TEKERLER

Tekerlekler	Yataklama					kg
100-050x20x09		50	20	22	9	30
100-070x23x09		70	23	24	9	40











KAPLAMALI MOBLEN TEKERLER

Tekerlekler	Yataklama					kg
320-050x20x09		50	20	22	9	30
320-075x25x09		75	25	25	9	40









KAPLAMALI MOBLEN TEKERLER

Tekerlekler	Yataklama					kg
400-100x32x12		100	32	36	12	80
400-125x32x12		125	32	38	12	100
401-100x32x12		100	32	36	12	80
401-125x32x12		125	32	38	12	100















SAC JANT GRİ LASTİK

Tekerlekler	Yataklama					kg
130-100x20x12		100	20	33	12	50
130-125x25x12		125	25	33	12	60
130-150x25x12		150	25	33	12	70



POLYAMİD ÜSTÜ LASTİK

Tekerlekler	Yataklama					kg
140-100x35x15		100	35	45	15	50
140-125x40x15		125	40	45	15	50
140-130x30x08		130	30	34	8	75
140-130x30x12		130	30	34	12	75
140-150x30x08		150	30	35	8	100
140-150x30x12		150	30	35	12	100
140-150x30x15		150	30	35	15	100
140-150x45x15		150	45	49	15	125
140-175x35x17		175	35	45	17	125
140-175x45x15		175	45	48	15	125
140-200x40x17		200	40	40	17	150
140-200x40x20		200	40	40	20	150
140-200x40x20G		200	40	45	20	175
140-220x45x20		220	45	55	20	175
140-250x50x20		250	50	56	20	200
140-300x50x20		300	50	61	20	250



350x4-Dolgu



350x4 Havali











350x4-1K Havali



350x4-2K Havali

EL ARABASI TEKERLERİ

Tekerlekler	Yataklama					
350x4 Dolgu		350	80	75	20	60
350x4 Havali		350	80	75	20	75
350x4-1K Havali		350	80	75	20	110
350x4-2K Havali		350	80	75	20	110









260x85x20 MHR



260x85x20 SHR

TAŞIMA ARABASI TEKERLERİ

Tekerlekler	Yataklama					
260x85x20 MHR		260	85	80	20	120
260x85x20 SHR		260	85	80	20	120



FORKLİFT TEKERLEKLER

Fabrika içerisinde kullandığınız forklift tekerlerinin üretimi ve poliüretan kaplaması yapılmaktadır.



TRANSPALET TEKERLER

Manuel veya elektrikli transpalet tekerlerinin üretimi ve deforme olan tekerlerin kaplaması yapılmaktadır.



POLİÜRETAN TEKERLER

İstedığınız ölçü ve ebatlarda döküm üstü poliüretan teker üretimi ve yenileme çalışması yapılmaktadır.



MERDANELER

Firmamız bünyesinde istediğiniz ebatlarda ve sertlik derecesinde Merdane üretimi yada sadece kaplaması yapılmaktadır.

MAKİNA TAMPONU

KOD	ÇAP	CİVATA	Taşıma Kapasitesi KG
ES - 1	80 mm	M 12X1.25	200 - 400
ES - 2	120 mm	M 16X1.5	400 - 600
ES - 3	160 mm	M 16X1.5	600 - 900
ES - 4	160 mm	M 20X1.5	900 - 1200
ES - 5	200 mm	M 20X1.5	1200 - 4000
ES - 6	200 mm	M 24X3	1500 - 5000
ES - 7	240 mm	M 24X2.5	2000 - 5000



MAKİNA TAMPONU (KROM KAPLI AYAKLAR)

KOD	ÇAP	CİVATA	Taşıma Kapasitesi KG
EL - 40	40 mm	M 10X50	75
EL - 40	40 mm	M 12X50	100
EL - 60	60 mm	M 10X50	100
EL - 60	60 mm	M 12X70	150
EL - 60	60 mm	M 16X100	200
EL - 80	80 mm	M 12X90	300
EL - 80	80 mm	M 16X100	400
EL - 80	80 mm	M 20X100	500
EL - 100	100 mm	M 12X90	350
EL - 100	100 mm	M 16X100	600
EL - 100	100 mm	M 20X150	800
EL - 120	120 mm	M 12X90	400
EL - 120	120 mm	M 16X100	500
EL - 120	120 mm	M 20X150	600
ES - 160	160 mm	M 16X100	800
ES - 160	160 mm	M 20X150	900



ÖZEL SOMUNLAR

KOD
12X1.5 Somun
16X1.5 Somun
20X1.5 Somun





ROTİL AYAKLAR

20x20
25x25
20x30
20x40
30x30
30x40
30x50
30x60
40x40
40x60
50x50



İÇTAPALAR

13
16
19
21
22
25
28
32
38
42
48
51
60
76t



DIŞTAPALAR

13
16
19
21
22
25
28
32



KARE İÇTAPALAR

15x15
15x25
20x20
20x30
20x40
25x25
25x40
30x30
30x40
30x50
40x40
40x60
50x50
60x60
80x80

DIŞTAPALAR

20x20
25x25
30x30
40x40



PLASTİKTUTAMAKLAR

PK1
PK2

NO:1
NO:2

Plastik Kulp
Plastik Kulp

BAKALİTTUTAMAKLAR

BK1
BK2

NO:1
NO:2

Bakalit Kulp M6
Bakalit Kulp M8



KOD	AÇIKLAMA	Paket Adedi
RAÜ 20X20X8	Rotil Üst 20X20 MT 8	50
RAÜ 25X25X3/8	Rotil Üst 25X25 MT 3/8	50
RAÜ 30X30X10	Rotil Üst 30X30 MT 10	50
RAÜ 40X40X10	Rotil Üst 40X40 MT 10	50
RAÜ 40X40X12	Rotil Üst 40X40 MT 12	50
RAÜ 40X40X16	Rotil Üst 40X40 MT 16	50
RAÜ 50X50X12	Rotil Üst 50X50 MT 12	50
RAÜ 50X50X16	Rotil Üst 50X50 MT 16	50
RAÜ 60X60X16	Rotil Üst 60X60 MT 16	50

KARE ROTİL AYARLI AYAK TAKIM

KOD	AÇIKLAMA	Paket Adedi
RATK 20X20X8	Rotil Takım 20X20 MT 8	50
RATK 25X25X3/8	Rotil Takım 25X25 MT 3/8	50
RATK 30X30X10	Rotil Takım 30X30 MT 10	50
RATK 40X40X10	Rotil Takım 40X40 MT 10	50
RATK 40X40X12	Rotil Takım 40X40 MT 12	50
RATK 40X40X16	Rotil Takım 40X40 MT 16	50
RATK 50X50X12	Rotil Takım 50X50 MT 12	50
RATK 50X50X16	Rotil Takım 50X50 MT 16	50
RATK 60X60X16	Rotil Takım 60X60 MT 16	50

DİKDÖRTGEN ROTİL AYAK ÜSTÜ

KOD	AÇIKLAMA	Paket Adedi
RADÜ 20X30X3/8	Rotil Üst 20X30 MT 3/8	50
RADÜ 20X40X10	Rotil Üst 20X40 MT 10	50
RADÜ 30X40X12	Rotil Üst 30X40 MT 12	50
RADÜ 30X50X10	Rotil Üst 30X50 MT 10	50
RADÜ 30X50X12	Rotil Üst 30X50 MT 12	50
RADÜ 40X60X12	Rotil Üst 40X60 MT 12	50
RADÜ 40X60X16	Rotil Üst 40X60 MT 16	50

DİKDÖRTGEN ROTİL AYARLI AYAK TAKIM

KOD	AÇIKLAMA	Paket Adedi
RADTK 20X30X3/8	Rotl Takım 20X30 MT 3/8	50
RADTK 20X40X10	Rotl Takım 20X40 MT 10	50
RADTK 30X40X12	Rotl Takım 30X40 MT 12	50
RADTK 30X50X10	Rotl Takım 30X50 MT 10	50
RADTK 30X50X12	Rotl Takım 30X50 MT 12	50
RADTK 40X60X12	Rotil Takım 40X60 MT 12	50
RADTK 40X60X16	Rotl Takım 40X60 MT 16	50



KOD	NO	ÇAP	MT	Paket Adedi
BYD 0-4	0	20	M 4	100
BYD 0-5	0	20	M 5	100
BYD 0-6	0	20	M 6	100
BYD 1-5	1	30	M 5	100
BYD 1-6	1	30	M 6	100
BYD 1-8	1	30	M 8	100
BYD 2-6	2	40	M 6	50
BYD 2-8	2	40	M 8	50
BYD 2-10	2	40	M 10	50
BYD 3-8	3	50	M 8	50
BYD 3-10	3	50	M 10	50
BYD 3-12	3	50	M 12	50
BYD 4-8	4	60	M 8	50
BYD 4-10	4	60	M 10	50
BYD 4-12	4	60	M 12	50
BYD 5-10	5	70	M 10	50
BYD 5-12	5	70	M 12	50
BYD 5-14	5	70	M 14	50
BYD 5-16	5	70	M 16	50

BAKALİT YILDIZ CİVATALI

KOD	NO	ÇAP	MT	Paket Adedi
BYE 0 4X10	0	20	M 4X10	100
BYE 0 5X10	0	20	M 5X10	100
BYE 0 6X10	0	20	M 6X10	100
BYE 1 5X15	1	30	M 5X15	100
BYE 1 6X15	1	30	M 6X15	100
BYE 1 8X15	1	30	M 8X15	100
BYE 2 6X20	2	40	M 6X20	50
BYE 2 8X20	2	40	M 8X20	50
BYE 2 10X20	2	40	M 10X20	50
BYE 3 8X25	3	50	M 8X25	50
BYE 3 10X25	3	50	M 10X25	50
BYE 3 12X25	3	50	M 12X35	50
BYE 4 8X30	4	60	M 8X30	50
BYE 4 10X30	4	60	M 10X30	50
BYE 4 12X30	4	60	M 12X30	50
BYE 5 10X35	5	70	M 10X35	50
BYE 5 12X35	5	70	M 12X35	50
BYE 5 14X35	5	70	M 14X35	50
BYE 5 16X35	5	70	M 16X35	50



KOD	ÖLÇÜ	AÇIKLAMA
LTT20X15X6	20X15X6 mm	Tek Civatalı
LTT20X20X6	20X20X6 mm	Tek Civatalı
LTT20X30X6	20X30X6 mm	Tek Civatalı
LTT25X20X6	25X20X6 mm	Tek Civatalı
LTT25X25X6	25X25X6 mm	Tek Civatalı
LTT25X30X6	25X30X6 mm	Tek Civatalı
LTT30X10X6	30X10X6 mm	Tek Civatalı
LTT30X15X6	30X15X6 mm	Tek Civatalı
LTT30X20X6	30X20X6 mm	Tek Civatalı
LTT30X20X8	30X20X8 mm	Tek Civatalı
LTT30X30X8	30X30X8 mm	Tek Civatalı
LTT30X40X8	30X40X8 mm	Tek Civatalı
LTT30X50X8	30X50X8 mm	Tek Civatalı
LTT40X15X8	40X15X8 mm	Tek Civatalı
LTT40X20X8	40X20X8 mm	Tek Civatalı
LTT40X20X10	40X20X10 mm	Tek Civatalı
LTT40X30X8	40X30X8 mm	Tek Civatalı
LTT40X30X10	40X30X10 mm	Tek Civatalı
LTT40X40X8	40X40X8 mm	Tek Civatalı
LTT40X40X10	40X40X10 mm	Tek Civatalı
LTT40X55X10	40X55X10 mm	Tek Civatalı
LTT40X65X8	40X65X8 mm	Tek Civatalı
LTT50X20X10	50X20X10 mm	Tek Civatalı
LTT50X30X10	50X30X10 mm	Tek Civatalı
LTT50X50X10	50X50X10 mm	Tek Civatalı
LTT55X35X10	55X35X10 mm	Tek Civatalı
LTT60X40X10	60X40X10 mm	Tek Civatalı
LTT60X40X12	60X40X12 mm	Tek Civatalı
LTT60X55X10	60X55X10 mm	Tek Civatalı
LTT60X60X12	60X60X12 mm	Tek Civatalı
LTT70X50X10	70X50X10 mm	Tek Civatalı
LTT70X60X12	70X60X12 mm	Tek Civatalı
LTT75X25X12	75X25X12 mm	Tek Civatalı
LTT75X55X12	75X55X12 mm	Tek Civatalı
LTT80X40X12	80X40X12 mm	Tek Civatalı
LTT80X40X16	80X40X16 mm	Tek Civatalı
LTT100X25X12	100X25X12 mm	Tek Civatalı
LTT100X25X16	100X25X16 mm	Tek Civatalı
LTT100X50X16	100X50X16 mm	Tek Civatalı
LTT100X50X20	100X50X20 mm	Tek Civatalı
LTT100X75X16	100X75X16 mm	Tek Civatalı
LTT100X100X16	100X100X16 mm	Tek Civatalı
LTT135X50X16	135X50X16 mm	Tek Civatalı
LTT150X50X16	150X50X16 mm	Tek Civatalı
LTT150X80X16	150X80X16 mm	Tek Civatalı
LTT150X100X16	150X100X16 mm	Tek Civatalı
LTT150X150X16	150X150X16 mm	Tek Civatalı



KOD	ÖLÇÜ	AÇIKLAMA
LTÇ20X15X6	20X15X6 mm	Çift Civatalı
LTÇ20X20X6	20X20X6 mm	Çift Civatalı
LTÇ20X30X6	20X30X6 mm	Çift Civatalı
LTÇ25X20X6	25X20X6 mm	Çift Civatalı
LTÇ25X25X6	25X25X6 mm	Çift Civatalı
LTÇ25X30X6	25X30X6 mm	Çift Civatalı
LTÇ30X20X6	30X20X6 mm	Çift Civatalı
LTÇ30X20X8	30X20X8 mm	Çift Civatalı
LTÇ30X30X8	30X30X8 mm	Çift Civatalı
LTÇ30X40X8	30X40X8 mm	Çift Civatalı
LTÇ30X50X8	30X50X8 mm	Çift Civatalı
LTÇ40X20X8	40X20X8 mm	Çift Civatalı
LTÇ40X20X10	40X20X10 mm	Çift Civatalı
LTÇ40X30X8	40X30X8 mm	Çift Civatalı
LTÇ40X30X10	40X30X10 mm	Çift Civatalı
LTÇ40X40X8	40X40X8 mm	Çift Civatalı
LTÇ40X40X10	40X40X10 mm	Çift Civatalı
LTÇ40X55X10	40X55X10 mm	Çift Civatalı
LTÇ40X65X8	40X65X8 mm	Çift Civatalı
LTÇ50X20X10	50X20X10 mm	Çift Civatalı
LTÇ50X30X10	50X30X10 mm	Çift Civatalı
LTÇ50X50X10	50X50X10 mm	Çift Civatalı
LTÇ55X35X10	55X35X10 mm	Çift Civatalı
LTÇ60X40X10	60X40X10 mm	Çift Civatalı
LTÇ60X40X12	60X40X12 mm	Çift Civatalı
LTÇ60X55X10	60X55X10 mm	Çift Civatalı
LTÇ60X60X12	60X60X12 mm	Çift Civatalı
LTÇ70X50X10	70X50X10 mm	Çift Civatalı
LTÇ70X60X12	70X60X12 mm	Çift Civatalı
LTÇ75X55X12	75X55X12 mm	Çift Civatalı
LTÇ80X40X12	80X40X12 mm	Çift Civatalı
LTÇ80X40X16	80X40X16 mm	Çift Civatalı
LTÇ100X50X16	100X50X16 mm	Çift Civatalı
LTÇ100X50X20	100X50X20 mm	Çift Civatalı
LTÇ100X75X16	100X75X16 mm	Çift Civatalı
LTÇ100X100X16	100X100X16 mm	Çift Civatalı
LTÇ135X50X16	135X50X16 mm	Çift Civatalı
LTÇ150X50X16	150X50X16 mm	Çift Civatalı
LTÇ150X80X16	150X80X16 mm	Çift Civatalı
LTÇ150X100X16	150X100X16 mm	Çift Civatalı
LTÇ150X150X16	150X150X16 mm	Çift Civatalı



SEHPA AYAK OYNAR BAŞ KOMPLE PLASTİK

KOD	NO	ÇAP	MT	Paket Adedi	Fiyat Ad / ₺
SAKP 2 10X50	2	60	10X50	25	
SAKP 2 10X100	2	60	10X100	25	
SAKP 2 12X50	2	60	12X50	25	
SAKP 2 12X100	2	60	12X100	25	
SAKP 2 16X50	2	60	16X50	25	
SAKP 2 16X100	2	60	16X100	25	
SAKP 2 16X150	2	60	16X150	25	
SAKP 2 20X50	2	60	20X50	25	
SAKP 2 20X100	2	60	20X100	25	
SAKP 2 20X150	2	60	20X150	25	
SAKP 3 10X50	3	80	10X50	25	
SAKP 3 10X100	3	80	10X100	25	
SAKP 3 12X50	3	80	12X50	25	
SAKP 3 12X100	3	80	12X100	25	
SAKP 3 16X50	3	80	16X50	25	
SAKP 3 16X100	3	80	16X100	25	
SAKP 3 16X150	3	80	16X150	25	
SAKP 3 16X200	3	80	16X200	25	
SAKP 3 20X50	3	80	20X50	25	
SAKP 3 20X100	3	80	20X100	25	
SAKP 3 20X150	3	80	20X150	25	
SAKP 3 20X200	3	80	20X200	25	
SAKP 4 10X50	4	110	10X50	25	
SAKP 4 10X100	4	110	10X100	25	
SAKP 4 12X50	4	110	12X50	25	
SAKP 4 12X100	4	110	12X100	25	
SAKP 4 16X50	4	110	16X50	25	
SAKP 4 16X100	4	110	16X100	25	
SAKP 4 16X150	4	110	16X150	25	
SAKP 4 16X200	4	110	16X200	25	
SAKP 4 20X50	4	110	20X50	25	
SAKP 4 20X100	4	110	20X100	25	
SAKP 4 20X150	4	110	20X150	25	
SAKP 4 20X200	4	110	20X200	25	

SEHPA AYAK OYNAR BAŞ KOMPLE ÇELİK

KOD	NO	ÇAP	MT	Paket Adedi	Fiyat Ad / ₺
SAKÇ 400845	1	40	8x45	8	
SAKÇ 401060	1	40	10x60	8	
SAKÇ 401260	1	40	12x60	8	
SAKÇ 601260	2	60	12x60	8	
SAKÇ 601660	2	60	16x60	8	
SAKÇ 801660	3	80	16x60	8	
SAKP 8016110	3	80	16x110	8	
SAKP 8016150	3	80	16x150	8	
SAKP 8020110	3	80	20x110	8	
SAKP 1001660	4	100	16x60	8	
SAKP 10016110	4	100	16x110	8	
SAKP 10020110	4	100	20x110	8	

SEHPA AYAK SABİT AĞIR TİP

KOD	NO	ÇAP	MT	Paket Adedi	Fiyat Ad / ₺
SA12016100	1	120	16x100	8	
SA12016160	1	120	16x160	8	
SA12020100	1	120	20x100	8	
SA12020160	1	120	20x160	8	
SA12024160	1	120	24x160	8	

SEHPA AYAK OYNAR BAŞ KOMPLE METAL DİŞİ

KOD	NO	ÇAP	MT	Paket Adedi	Fiyat Ad / ₺
SAMD 3 10	3	60	MT 10	25	
SAMD 3 12	3	60	MT 12	25	
SAMD 3 16	3	60	MT 16	25	
SAMD 4 10	4	80	MT 10	25	
SAMD 4 12	4	80	MT 12	25	
SAMD 4 16	4	80	MT 16	25	
SAMD 5 10	5	110	MT 10	25	
SAMD 5 12	5	110	MT 12	25	
SAMD 5 16	5	110	MT 16	25	



SEHPA AYAK OYNAR BAŞ KOMPLE PLASTİK

KOD	NO	ÇAP	MT	Paket Adedi	Fiyat Ad / ₺
SAKP 2 10X50	2	60	10X50	25	
SAKP 2 10X100	2	60	10X100	25	
SAKP 2 12X50	2	60	12X50	25	
SAKP 2 12X100	2	60	12X100	25	
SAKP 2 16X50	2	60	16X50	25	
SAKP 2 16X100	2	60	16X100	25	
SAKP 2 16X150	2	60	16X150	25	
SAKP 2 20X50	2	60	20X50	25	
SAKP 2 20X100	2	60	20X100	25	
SAKP 2 20X150	2	60	20X150	25	
SAKP 3 10X50	3	80	10X50	25	
SAKP 3 10X100	3	80	10X100	25	
SAKP 3 12X50	3	80	12X50	25	
SAKP 3 12X100	3	80	12X100	25	
SAKP 3 16X50	3	80	16X50	25	
SAKP 3 16X100	3	80	16X100	25	
SAKP 3 16X150	3	80	16X150	25	
SAKP 3 16X200	3	80	16X200	25	
SAKP 3 20X50	3	80	20X50	25	
SAKP 3 20X100	3	80	20X100	25	
SAKP 3 20X150	3	80	20X150	25	
SAKP 3 20X200	3	80	20X200	25	
SAKP 4 10X50	4	110	10X50	25	
SAKP 4 10X100	4	110	10X100	25	
SAKP 4 12X50	4	110	12X50	25	
SAKP 4 12X100	4	110	12X100	25	
SAKP 4 16X50	4	110	16X50	25	
SAKP 4 16X100	4	110	16X100	25	
SAKP 4 16X150	4	110	16X150	25	
SAKP 4 16X200	4	110	16X200	25	
SAKP 4 20X50	4	110	20X50	25	
SAKP 4 20X100	4	110	20X100	25	
SAKP 4 20X150	4	110	20X150	25	
SAKP 4 20X200	4	110	20X200	25	



TOPUZ

SİYAH BAKALİT MAMULDENDİR.

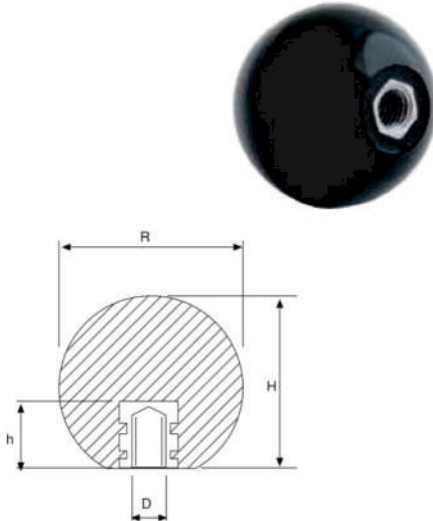

NO	ØR	D	h	H	KOD	PAKET ADEDİ	FİYAT
1	25	M.5	10	24	T 25 5	100	
1	25	M.6	12	24	T 25 6	100	
1	25	M.8	12	24	T 25 8	100	
2	30	M.6	12	29	T 30 6	100	
2	30	M.8	12	29	T 30 8	100	
2	30	M.10	12	29	T 30 10	100	
3	35	M.6	17	34	T 35 6	50	
3	35	M.8	17	34	T 35 8	50	
3	35	M.10	17	34	T 35 10	50	
4	40	M.8	17	39	T 40 8	50	
4	40	M.10	17	39	T 40 10	50	
4	40	M.12	17	39	T 40 12	50	
5	46	M.8	22	44	T 46 8	50	
5	46	M.10	22	44	T 46 10	50	
5	46	M.12	22	44	T 46 12	50	
6	50	M.8	22	49	T 50 8	50	
6	50	M.10	22	49	T 50 10	50	
6	50	M.12	22	49	T 50 12	50	
6	50	M.14	22	49	T 50 14	50	
6	50	M.16	22	49	T 50 16	50	

6 KÖŞE KAPLAMALI ÖZEL DEMİR BURÇLUDUR.

www.dalgicteker.com.tr

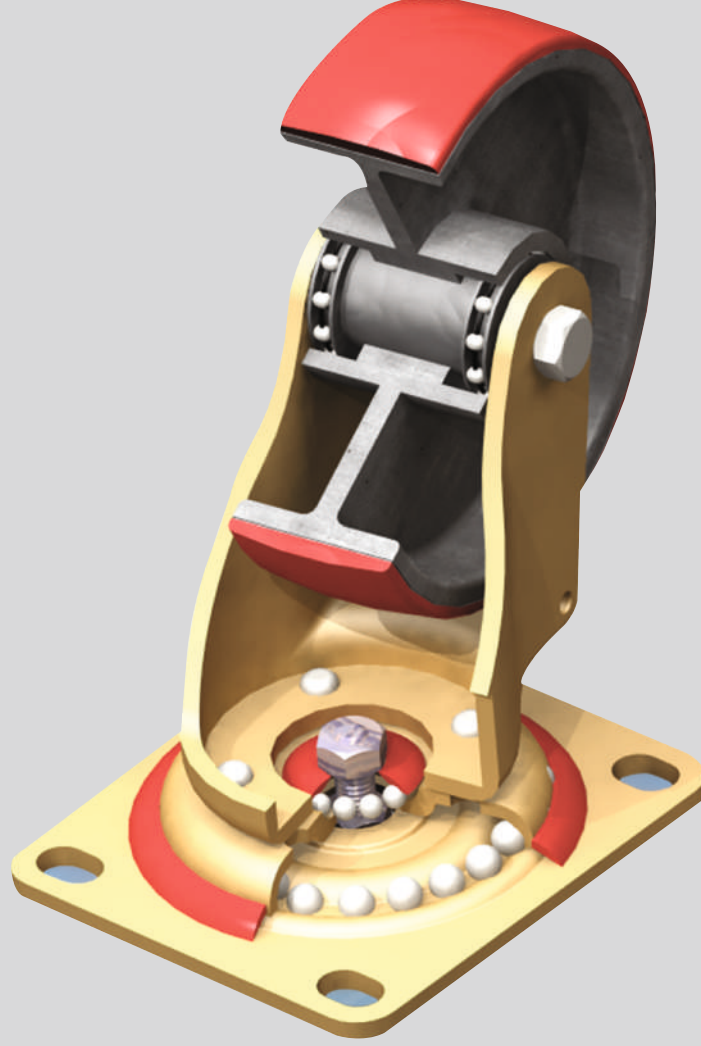

dolunay
GİRİTİM



Dalgıç Teker Şirketler Grubu

+90 (264) 300 10 34 ☎ +90 (264) 300 10 35

📍 Güney Mobilyacılar San. Sit. 1290 Sk. No: 28 Erenler/Sakarya/TURKEY

✉ info@dalgicteker.com.tr

